

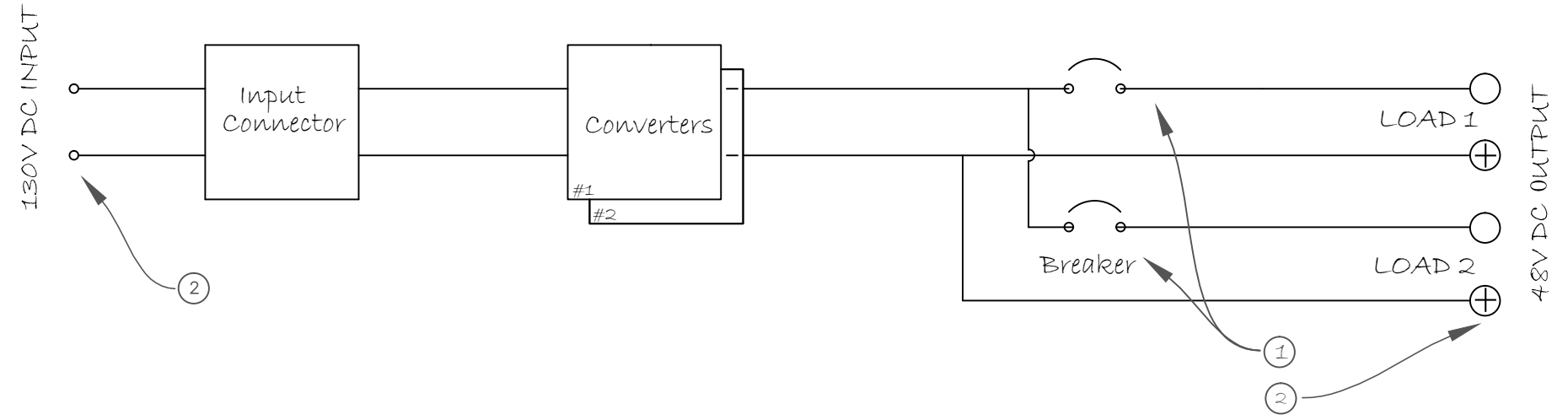

REVISIONS				
ZONE	REV	DESCRIPTION	DATE	APPROVED
	1	Customer Drawing / Circuit; Electrical	02/2020	YES

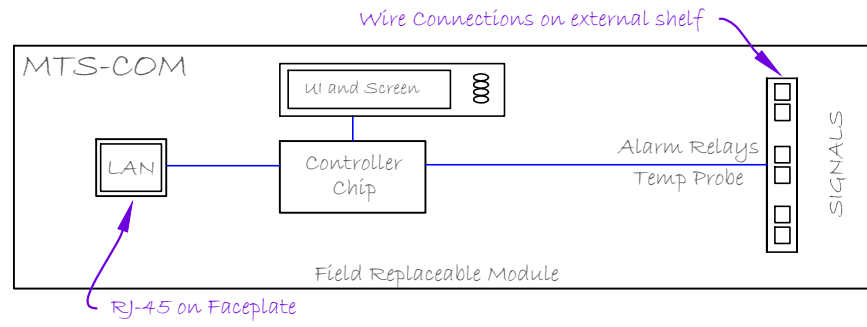

NOTES:
 1. Circuit Breakers rated to 50 amps, mid-trip alarm.
 2. Terminal Barrier Strip w/ protective cover.

APPLICATIONS:
 1. MTD48/25-130-1U
 2. MTD48/50-130-1U

Majorpower Corporation 7011 Industrial Dr. Mebane, North Carolina 27302 (919) 563-6610		Majortel DC Power		
		MTD48/50-130-1U		
	SIZE	DWG NO.	REV	
		MTD-D202-OLE	V13A	
www.majorpower.com	SCALE N/A	SHEET	1 of 1	